



(Front View) SD72W (Rear View)

FEATURES

- 10oz dual cone speaker provides familiar response & performance
- Quality 5 watt-dual voltage transformer
- Attractive CRS white powder coat baffle
- Individually packaged for stocking & ordering convenience

APPLICATION

The SD72W is an aggressively priced, high quality speaker/baffle transformer package suitable for most any paging or background application including retail stores, restaurants, schools and other institutional facilities.

GENERAL DESCRIPTION

The speaker used in the SD72W is the next generation of Atlas high performance cone loudspeakers, very similar to the preceding C-Series speakers. The similarity in the sonic qualities ensures that contractors and designers who have worked with the Atlas Sound C-Series in the past will know exactly what to expect when they use the SD72W. Model SD72W is a dual cone, 25 watt 8" (205mm) loudspeaker with a 10oz. (260g) ceramic magnet. It includes a curvilinear, treated paper cone for lower harmonic distortion. The loudspeaker is also equipped with a full 1" diameter copper voice coil with a black anodized aluminum former for better power dissipation. Model SD72W operates within a frequency response range of 45Hz-19kHz (nominal) with a sensitivity of 97dB and a dispersion angle of 105°. Package includes factory installed 25/70.7V line matching transformer with tap selections ranging from .25 to 5 watts. The SD72W includes a factory installed CRS baffle with concealed loudspeaker mounting studs and includes screw mount hardware. The SD72W baffle features standard mounting holes to accommodate the majority of Atlas Sound 8" tile bridges, mounting rings and enclosures. When specifying mounting hardware be advised that the dimensions of the SD72W baffle match the Atlas Sound Model 62-8. The baffle finish is white powder coat epoxy.

ARCHITECT & ENGINEER SPECIFICATIONS

Unit shall be Atlas Sound 8" loudspeaker Model SD72W utilizing line matching transformer and white CRS baffle. It shall have a (10oz.) ceramic magnet and a seamless cone. Frequency response range shall be 45Hz-19kHz (nominal). Sensitivity shall be 97dB 1W/1M. Voice coil shall be black anodized aluminum to help dissipate heat, have an impedance of 8 ohms and a diameter of 1" (25mm). Transformer primary voltage shall be 25V/70.7V with a frequency response range of 45Hz-19kHz (nominal). Insertion loss shall not exceed 1.5dB. Unit shall include factory installed CRS baffle. Baffle shall include welded speaker mounting studs and all necessary hardware to match the baffle to associated optional hardware. Baffle overall diameter shall not exceed 12 3/4" (324mm) Baffle shall be finished in white powder coat epoxy.

SD72W SPECIFICATIONS

Size	8" (205mm)
Power Handling	25 Watts Peak, 15 Watts RMS
Sensitivity	97dB Average
Impedance	8 Ohms Nominal
Frequency Response	45Hz-19kHz Nominal, 55Hz-8kHz +5dB
Dispersion	105° (2kHz Octave Band, -6dB Points)
Diameter & Depth	8.125" (205mm) Dia. & 2.875" (73mm) Deep
Mounting Dimensions	7.625" (194mm) Bolt Circle
Cone Material	Treated Paper
Surround Material & Damping	Damped Self Edge
Flux Density	10,600 Gauss, 1.06 Tesla
Magnet Weight	Nominal, 10oz. (260g)
Basket Material	Stamped Plated 20 ga. CRS
VC Diameter	1" (25mm)
VC Material	Copper
VC Former Material	Black Anodized Aluminum
VC Winding Width	.225"
Top Plate Thickness	.239"
Weight	32oz. (908g)
THIELE-SMALL PARAMETERS	
Pe	15 watts
Fs	125Hz
Xmax	.03"
Resistance	7.3 ohms
Qts	0.8
Qes	0.95
Qms	5.2
BL	7.9 N/A
Efficiency	1.90%
Vas	.32 (ft ³)
Sd	33.2 (in ²)
Le@1kHz	.36 mH
Mms	.39oz.
Cms	.024 in./lb.
Transformer Specifications	
Frequency Response	100Hz-10kHz (+/-1.5dB)
Primary Taps (Watts)	.25, .5, 1, 2, & 5
Secondary Impedance (ohms)	8
Maximum Insertion Loss	1.5dB
Primary Termination	6" (152mm) Com. Lead Color Coded
Core Size	1/2" X 3/4" (16 X 16mm)
Power Rating (Watts)	5

Specifications subject to change without notice



1601 JACK MCKAY BLVD. / ENNIS, TEXAS 75119 U.S.A.
 TELEPHONE: (800) 876-3333 / FAX (800) 765-3435

AtlasSound.com

SD72W Baffle Information							
MODEL	DIMENSIONS				MOUNTS		OPTIONAL TILEBRIDGE
	DIA. (A)	PROJECTS (B)	(C)*	(D)**	ENCLOSURE (OR)	MTG. RING	
SD72W	12 $\frac{3}{4}$ " (324mm)	$\frac{1}{4}$ " (6mm)	7 $\frac{5}{8}$ " (194mm)	11 $\frac{1}{4}$ " (286mm)	(EZ)95-8 Series, T95-8 Series, EZ96-8, CS95-8, 199-8, Q408, 96-8 Series ▲	75-8(E1)(E2), 76-8(E1)(E2), P77-8, P78-8	81-8R(S) EQ81s ▲

* (C) Speaker mounting stud pattern.
 ** (D) Baffle mounting hole pattern.
 ▲ EQ81 tile bridge works only with 96-8 Series enclosures.

TAP WATTAGE	70.7V
0.25	Red
0.5	White
1	Yellow
2	Blue
5	Brown
COMMON	Black

TAP WATTAGE	25V
0.25	Blue
0.5	Gray
1	Green/White
2	Violet
5	Orange
COMMON	Black

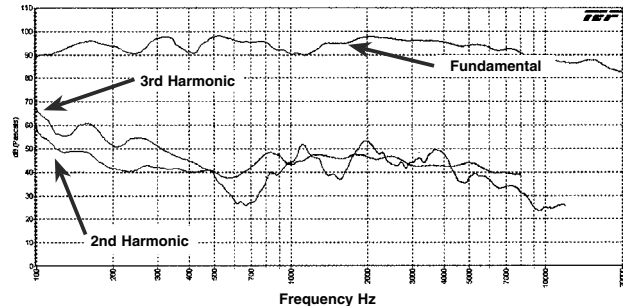
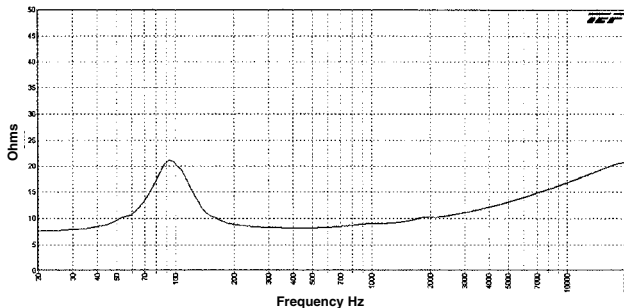
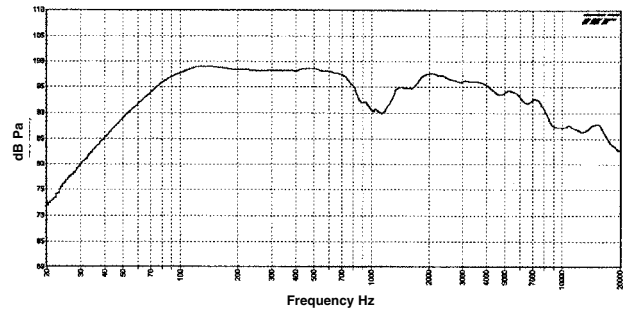
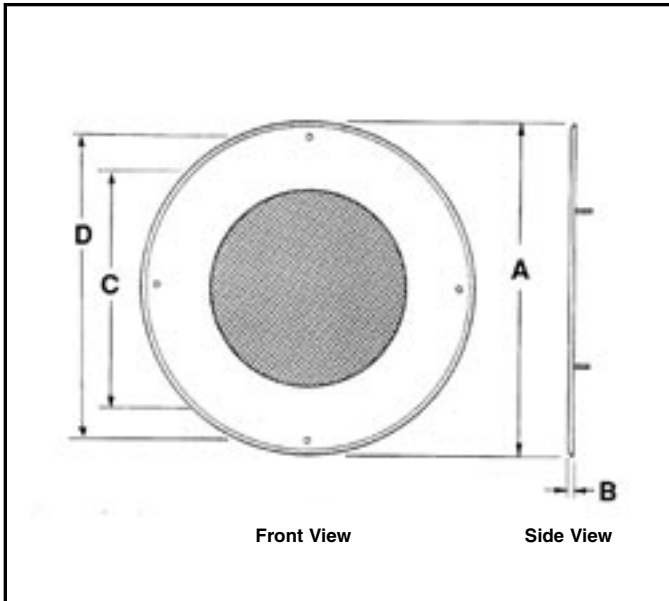

SD72W OCTAVE BAND POLARS

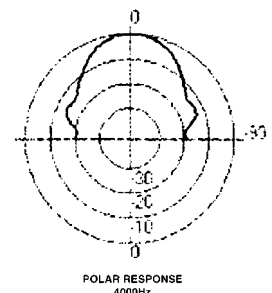
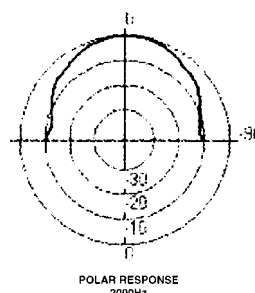
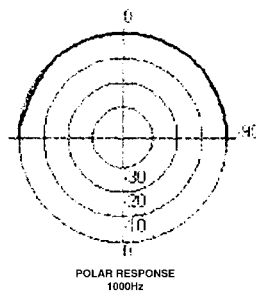
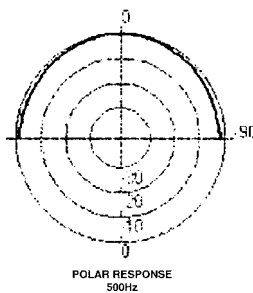

Specifications subject to change without notice



1601 JACK MCKAY BLVD. / ENNIS, TEXAS 75119 U.S.A.
 TELEPHONE: (800) 876-3333 / FAX (800) 765-3435

AtlasSound.com